

KEURIG®

K·Slim™

Use & Care Guide

Get the most from your new
Keurig® coffee maker



Before You Brew

1 Plug & Place

Remove packing tape from coffee maker. Plug into a grounded outlet. Place mug on drip tray.

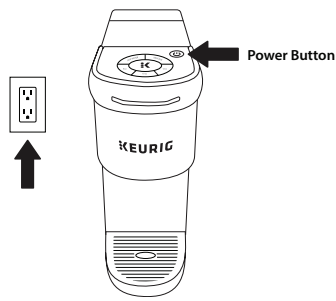

3 Lift & Lower

Lift and lower the handle. **Do not insert a K-Cup® pod.** The coffee maker will power on automatically.



2 Rinse & Fill

Remove the water reservoir lid, then lift the reservoir straight up to remove it.

Rinse reservoir with fresh water and fill to the **MAX FILL** line.

Replace water reservoir, making sure the lock tabs engage with the coffee maker. Replace lid.

NOTE: Do not use distilled water.

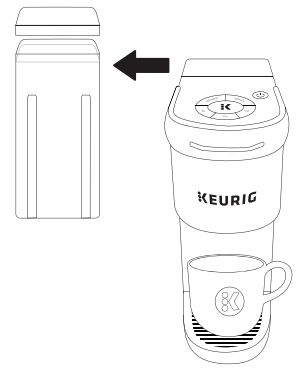

4 Cleansing Brew

The 3 cup sizes will blink. Press the **8oz** button, then press the blinking **brew button** to start a cleansing brew. Pour the hot water into the sink.

The one-time setup process is now complete and you are ready to brew!

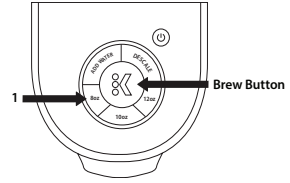

Brew Your First Cup

5 Place Mug & Pod

Place a mug on the drip tray. If using a travel mug, remove the drip tray and place the mug on the drip tray base. Lift the handle and place a K-Cup® pod in the K-Cup® pod holder. Lower the handle completely to close the lid.

Do not remove the foil lid on the K-Cup® pod.

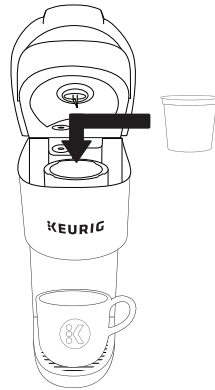

6 Brew & Enjoy!

The three brew size buttons will blink. Select your brew size, then press the blinking **brew button**. The **brew button** will remain illuminated while brewing. Brewing is complete when the buttons are no longer illuminated. Lift the handle and recycle the K-Cup® pod in 3 easy steps*.

CAUTION: While brewing, there is extremely hot water in the K-Cup® pod holder. To avoid injury, do not lift the handle during the brewing process.

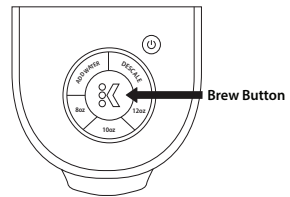

Coffee Maker Features

Smart Start heats then brews in one simple process. No need to wait for the coffee maker to heat before selecting brew size. Simply power on your coffee maker by lifting the handle, insert K-Cup® pod, then select your brew size. Press the **brew button**. The coffee maker will heat, then automatically begin brewing.

Auto Off automatically turns your coffee maker off 5 minutes after the last brew for energy savings.

High Altitude To ensure your coffee maker works properly at higher altitudes (1,500 meters/5,000 feet) please enable the High Altitude Brewing Mode on your coffee maker.

1. Power the coffee maker off while it is plugged in.
2. Press and hold the **brew** and **8oz** buttons for 3 seconds. The 12oz button will illuminate to confirm that the High Altitude Brewing Mode has been enabled.

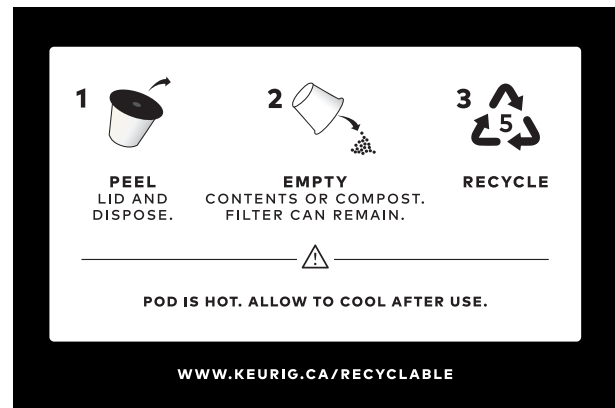

*Recyclable in select locations. Visit keurig.ca/recyclable for more information.

Caring For Your Coffee Maker

Regular cleaning keeps your coffee maker running smoothly. Always be sure to turn off and unplug your coffee maker before cleaning.



Coffee Maker Exterior

Keep your Keurig® coffee maker looking its best by cleaning the exterior from time to time. Just clean with a damp, soapy, lint-free, non-abrasive cloth. Never immerse the coffee maker in water or other liquids.

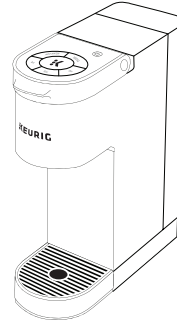

Water Reservoir

The water reservoir should be cleaned periodically by wiping the inside of the reservoir and underside of the lid with a damp, non-abrasive, lint-free cloth. Do not dry the inside of the water reservoir with a cloth as lint may remain. Allow the reservoir to dry completely.

Drip Tray

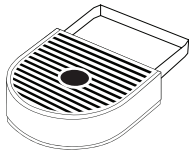

The drip tray can hold up to 237 ml/8 oz of overflow and should be emptied and cleaned occasionally. To remove, slide it toward you, keeping it level to avoid spilling. Rinse and clean with a damp, soapy, lint-free, non-abrasive cloth.

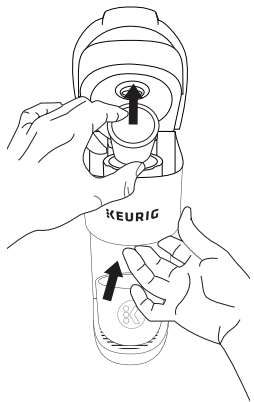

K-Cup® Pod Holder

To remove the K-Cup® pod holder from the coffee maker, lift the handle and grasp the top of the K-Cup® pod holder with one hand while pushing up on the bottom of the K-Cup® pod holder from underneath with the other until it releases. After cleaning, align the K-Cup® pod holder with the opening using the two front ribs as a guide and snap into place from the top.

CAUTION: There are sharp needles that puncture the K-Cup® pod above the K-Cup® pod holder and in the bottom of the K-Cup® pod holder. To avoid risk of injury, do not put your fingers in the K-Cup® pod holder.

NOTE: Always remove and recycle the used K-Cup® pod after brewing.

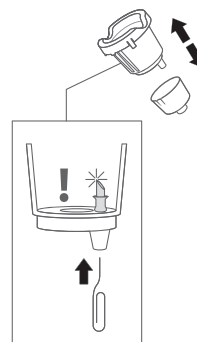

Exit Needle

Remove the pod holder assembly and detach the funnel. Locate the exit needle on the inside bottom of the K-Cup® pod holder. Insert a straightened paper clip into the exit needle to loosen any coffee grounds.

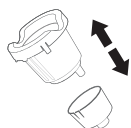

Funnel

Washing the funnel ensures a fresh beverage experience. The funnel should be washed regularly and can be removed from the K-Cup® pod holder by pulling on it until it pops off. To replace it, orient the snaps to the indent and just snap it back onto the K-Cup® pod holder.

Entrance Needle

Lift the coffee maker handle and locate the entrance needle on the underside of the lid. To clean both holes in the needle, hold the coffee maker handle in the upward position and with your other hand, carefully insert a straightened paper clip into both holes. Gently move it around to loosen any coffee grounds. Lower the handle completely and run two water-only brew cycles. Do not insert a K-Cup® pod.

TIP: Refer to keurig.ca/support_1 for video instructions on cleaning the entrance/exit needles.

Descaling Your Coffee Maker

You should descale your coffee maker every 3 months. Properly follow the descaling procedure.

Depending on the mineral content of your water, calcium deposits or scale may build up in your coffee maker. Scale is non-toxic but if left unattended can hinder coffee maker performance. Regularly descaling your coffee maker every 3 months helps maintain the heating element, and other internal parts that come in contact with water. Calcium deposits may build up faster, making it necessary to descale more often.

Descaling Procedure

Before you begin, you will need a large ceramic mug, fresh water, Keurig® Descaling Solution, and access to a sink. Do not use a paper cup. Ensure that there is no beverage pod in the K-Cup® pod holder. Please allow approximately 15-20 minutes for the descaling procedure.

STEP 1: Descaling Solution Rinse

Pour the entire bottle of Keurig® Descal Solution into an emptied water reservoir. Then, fill the empty bottle with water and pour into the water reservoir. **Do not insert a K-Cup® pod.**

Place a large mug on the drip tray. To activate Descale Mode, begin with the coffee maker powered off, then press and hold the **8oz** and **12oz** buttons together for 3 seconds until the **DESCALE** light turns solid.

When the **brew button** begins flashing, press the **brew button** to start the cleansing rinse brew. Pour the hot liquid into the sink. Repeat the cleansing rinse process until the **ADD WATER** light illuminates.

STEP 2: Rest & Rinse

Empty the water reservoir and refill to the **MAX** fill line with fresh water.

STEP 3: Fresh Water Rinse

Press the **brew button** once it begins flashing. Repeat this process until the **ADD WATER** light illuminates.

The coffee maker will now exit Descale Mode and will be ready for use!

NOTE: The cleaning action of Keurig® Descaling Solution may result in a "foam" dispensed from the coffee maker. This is natural, as the solution is reacting with the scale inside. For a coffee maker that is heavily scaled, the coffee maker may not fill properly after the descaler is added. If this occurs, you may see only a small or no output dispensed, followed by the sound of air blowing out. If this occurs:

- Turn off and unplug the coffee maker.
- If there is Keurig® Descaling Solution in the water reservoir, discard the contents, rinse the water reservoir thoroughly and refill with water.
- Plug the coffee maker back in, power on, and repeat the Step 3 Fresh Water Rinse cycle. The coffee maker should begin to function normally as the solution is rinsed out and the scale is removed. If problem persists, allow coffee maker to sit unplugged for at least 30 minutes before continuing with the rinse.

Troubleshooting

Grounds in Your Coffee

Grounds may have gathered in the exit or entrance needles and can be cleaned using a straightened paper clip or similar tool.

- Clean the exit needle of the K-Cup® pod holder. Refer to the Exit Needle care instructions.
- Clean the coffee maker entrance needle. Refer to the Entrance Needle care instructions.

Coffee Maker Will Not Brew

- A minimum of 177 ml/6 oz of water is required to brew. Add an additional 59 ml/2 oz of water to the reservoir to ensure the minimum fill level has been met, then press the brew button. Repeat until the coffee maker begins to dispense.

Brewing a Partial Cup

- Power the coffee maker off. Press and hold the brew button and 12oz button for 5 seconds until water starts dispensing. Then release and let the water purge. Discard the contents into the sink. Press the power button to restart.
- The exit needle may be clogged. Refer to the Exit Needle care instructions.
- Clean the K-Cup® Pod Holder, see K-Cup® Pod Holder care instructions.
- The coffee maker may need to be descaled. If you have repeated the descale procedure on your coffee maker

two times and it is still only brewing a partial cup, contact Customer Service.

Coffee Maker Does Not Have Power or Shuts Off

- Make sure that the power button has been turned on.
- Plug coffee maker into its own grounded outlet. If the electric circuit is overloaded with other appliances, your coffee maker may not function properly. The coffee maker should be operated on its own circuit, separate from other appliances.
- For energy savings, the coffee maker automatically turns off 5 minutes after the last brew. Press the power button to restart.
- If the coffee maker still doesn't have power, contact Customer Service.

Click or Call!

Have Questions?

We're here to help. Visit keurig.ca/support_1 for step-by-step videos on cleaning, descaling, and more.



Still Need Help?

Give us a call at
1-800-361-5628

Helpful Hints

Water quality varies greatly. If you notice an undesirable taste in your beverage (such as chlorine or mineral tastes), we recommend using bottled or filtered water. Do not use distilled water.

Service

Beyond these recommended cleaning and maintenance procedures, this coffee maker is not user serviceable. For service, please refer to the Warranty section of this guide.

Storage

Empty the water reservoir before storing or transporting and take care to ensure that you store your coffee maker in a safe and frost-free environment. When you prepare to use it after storage, we recommend rinsing the water reservoir with fresh water and descaling the coffee maker as detailed in the Descaling your Coffee Maker section.

If you plan to move your coffee maker to a different location, turn the coffee maker off, unplug it, and empty the water reservoir. If your coffee maker has been in an environment below freezing, please be sure to let it warm to room temperature for at least 2 hours before using.

Warranty

LIMITED ONE YEAR WARRANTY

Keurig Green Mountain, Inc. (Keurig) warrants that your coffee maker will be free of defects in materials or workmanship under normal home use for one year from the date of purchase. It is recommended that you register your coffee maker on keurig.ca/welcome so that your purchase information will be stored in our system. Keurig will, at its option, repair or replace a defective coffee maker without charge upon its receipt of proof of the date of purchase. If a replacement coffee maker is necessary to service this warranty, the replacement coffee maker may be new or reconditioned. If a replacement coffee maker is sent, a new limited one year warranty will be applied to the replacement coffee maker.

This warranty only applies to coffee makers operated in the United States and Canada. This warranty gives you specific legal rights, and you may also have other rights that vary from state to state and, in the case of Canada, from province to province.

Only the use of Keurig® K-Cup® brand pods and accessories will guarantee the proper functioning and lifetime of your Keurig® coffee maker. Any damage to or malfunction of your coffee maker resulting from the use of non-Keurig® pods and accessories may not be covered by this warranty or may result in a service fee if the damage or malfunction is determined to be caused by such use.

WHAT IS NOT COVERED BY THE LIMITED WARRANTY?

THIS WARRANTY DOES NOT COVER CONSEQUENTIAL OR INCIDENTAL DAMAGES SUCH AS PROPERTY DAMAGE AND DOES NOT COVER INCIDENTAL COSTS AND EXPENSES RESULTING FROM ANY BREACH OF THIS WARRANTY, EVEN IF FORESEEABLE. Some states or provinces do not allow the exclusion or limitations of incidental or consequential damages, so the above limitation or exclusion may not apply to you depending on the state or province of purchase.

Nor does this warranty cover damages caused by use of non-Keurig® pods or accessories, services performed by anyone other than Keurig or its authorized service providers, use of parts other than genuine Keurig® parts, or external causes such as abuse, misuse, inappropriate power supply, or acts of God.

OTHER LIMITATIONS

THIS WARRANTY IS EXCLUSIVE AND IS IN LIEU OF ANY OTHER EXPRESS WARRANTY, WHETHER WRITTEN OR ORAL. IN ADDITION, KEURIG HEREBY SPECIFICALLY DISCLAIMS ALL OTHER WARRANTIES WITH RESPECT TO YOUR KEURIG® COFFEE MAKER, INCLUDING ANY IMPLIED WARRANTY OF MERCHANTABILITY OR FITNESS FOR ANY PARTICULAR PURPOSE. Some states or provinces do not allow disclaimers of such implied warranties or limitations on how long an implied warranty lasts, so the above limitation may not apply to you depending on the state or the province of purchase.

HOW DO YOU OBTAIN WARRANTY SERVICE?

Keurig® coffee makers are high-quality appliances and, with proper care, are intended to provide years of satisfying performance. However, should the need arise for warranty servicing, simply call Keurig Customer Service at our toll-free phone number 1-800-361-5628. Please do not return your coffee maker for servicing without first speaking to Keurig Customer Service to obtain a Return Materials Authorization (RMA) number. Keurig® coffee makers returned without a RMA number will be returned to the sender without servicing.

K·Slim™

SINGLE SERVE COFFEE MAKER

- A. Handle
- B. K-Cup® Pod Holder (B and C are the K-Cup® Pod Holder Assembly)
- C. Funnel
- D. K-Cup® Pod Assembly Housing
- E. Drip Tray Plate
- F. Drip Tray
- G. Drip Tray Base
- H. Water Reservoir Lid
- I. Water Reservoir

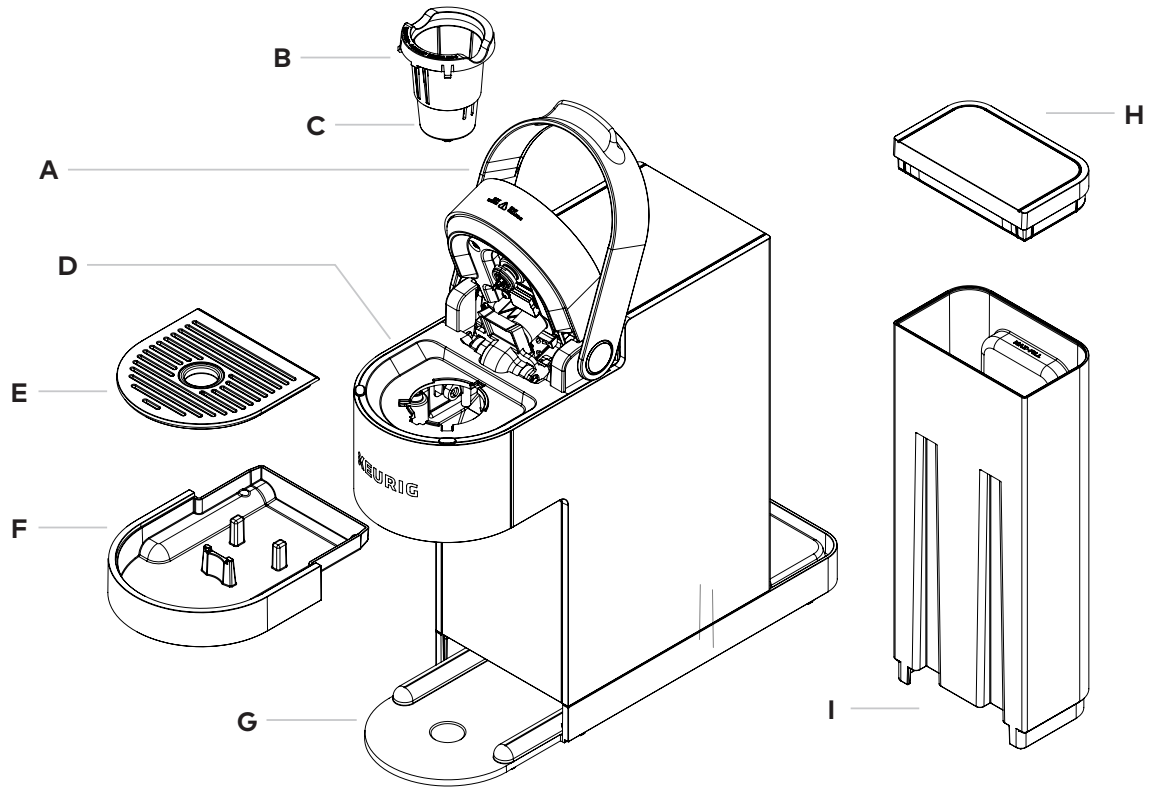

For replacement parts, please visit www.keurig.ca

Coffeehouse taste in your own home.

**REGISTER YOUR NEW KEURIG®
COFFEE MAKER**

and receive a special savings offer.
Restrictions apply. See keurig.ca for details.

keurig.ca/welcome